

PRODUCT DATA SHEET

OPEN UP

High Adjustable Table System

DESIGN

T Design Studio



Open-up offers practical and functional details with its design. With its height adjustable feature, it directs employees to move, support the physiology and enables to create a healthier working space.

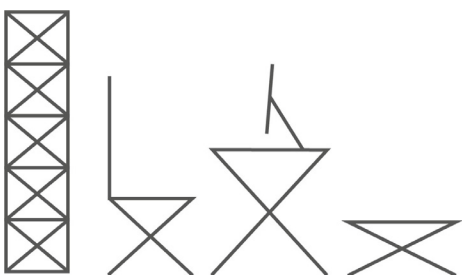

tunaofis

VARIATIONS

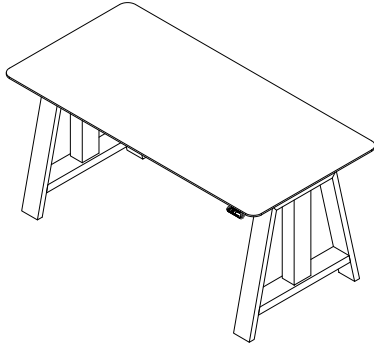

Single Desk

Table Top		
Product Code	L/W/H (cm)	Material
8256 01140080 01	140x80x2,5	Melamine
8256 01140080 02	140x80x2,5	Laminate
8256 01140080 03	140x80x2,5	Veneer

Gross Weight and Packaging	
	Melamine: 12,6 kg Laminate: 15,75 kg Veneer: 15,75 kg 143x83x5 cm

Total Packaging*	
	Melamine: 56,3 kg Laminate: 59,4 kg Veneer: 59,4 kg 0,059 m ³



Leg / B Type		
Product Code	L/W/H (cm)	Material
8256 100292 0000 06	70x19,8x65,3	Solid Wood

Gross Weight	
	15,3 kg



Packaging	
	75x25x75 cm (0,141 m ³) 16 kg

Table Top		
Product Code	L/W/H (cm)	Table Top
8256 01160080 01	160x80x2,5	Melamine
8256 01160080 02	160x80x2,5	Laminate
8256 01160080 03	160x80x2,5	Veneer

Gross Weight and Packaging	
	Melamine: 19,8 kg Laminate: 24 kg Veneer: 24 kg 163x83x5 cm



Total Packaging*	
	Melamine: 63,5 kg Laminate: 67,7 kg Veneer: 67,7 kg 0,068 m ³

Table Top		
Product Code	L/W/H (cm)	Material
8256 01180080 01	180x80x2,5	Melamine
8256 01180080 02	180x80x2,5	Laminate
8256 01180080 03	180x80x2,5	Veneer

Gross Weight and Packaging	
	Melamine: 21,6 kg Laminate: 27 kg Veneer: 27 kg 183x83x5 cm

Total Packaging*	
	Melamine: 65,3 kg Laminate: 70,7 kg Veneer: 70,7 kg 0,076 m ³

* Total packaging include two leg, one table top, one teleskopik travers and one lift setpack.

VARIATIONS



Leg / B1 Type		
Product Code	L/W/H (cm)	Material
8256 100294 0000 08	70x19,8x65,3	Metal

Gross Weight	
	20 kg



Packaging	
	75x25x75 cm (0,141 m ³) 21 kg

Table Top		
Product Code	L/W/H (cm)	Material
8256 02140080 01	140x80x2,5	Melamine
8256 02140080 02	140x80x2,5	Laminate
8256 02140080 03	140x80x2,5	Veneer

Gross Weight and Packaging	
	Melamine: 12,6 kg Laminate: 15,75 kg Veneer: 15,75 kg 143x83x5 cm



Total Packaging*	
	Melamine: 66,3 kg Laminate: 69,4 kg Veneer: 69,4 kg 0,059 m ³

Table Top		
Product Code	L/W/H (cm)	Table Top
8256 02160080 01	160x80x2,5	Melamine
8256 02160080 02	160x80x2,5	Laminate
8256 02160080 03	160x80x2,5	Veneer

Gross Weight and Packaging	
	Melamine: 19,8 kg Laminate: 24 kg Veneer: 24 kg 163x83x5 cm



Total Packaging*	
	Melamine: 73,5 kg Laminate: 77,7 kg Veneer: 77,7 kg 0,068 m ³

Table Top		
Product Code	L/W/H (cm)	Material
8256 02180080 01	180x80x2,5	Melamine
8256 02180080 02	180x80x2,5	Laminate
8256 02180080 03	180x80x2,5	Veneer

Gross Weight and Packaging	
	Melamine: 21,6 kg Laminate: 27 kg Veneer: 27 kg 183x83x5 cm

Total Packaging*	
	Melamine: 75,3 kg Laminate: 80,7 kg Veneer: 80,7 kg 0,076 m ³

* Total packaging include two leg, one table top, one telescopic travers and one lift setpack.

VARIATIONS





Leg / B2 Type		
Product Code	L/W/H (cm)	Material
8256 100296 0000 19	70x10x59,5	Metal+Melamine
Gross Weight		
	21 kg	
Packaging		
	75x25x75 cm (0,141 m ³) 22 kg	



Table Top		
Product Code	L/W/H (cm)	Material
8256 03140080 01	140x80x2,5	Melamine
8256 03140080 02	140x80x2,5	Laminate
8256 03140080 03	140x80x2,5	Veneer
Gross Weight and Packaging		
	Melamine: 12,6 kg Laminate: 15,75 kg Veneer: 15,75 kg 143x83x5 cm	
Total Packaging*		
	Melamine: 68,3 kg Laminate: 71,4kg Veneer: 71,4 kg 0,059 m ³	





Table Top		
Product Code	L/W/H (cm)	Table Top
8256 03160080 01	160x80x2,5	Melamine
8256 03160080 02	160x80x2,5	Laminate
8256 03160080 03	160x80x2,5	Veneer
Gross Weight and Packaging		
	Melamine: 19,8 kg Laminate: 24 kg Veneer: 24 kg 163x83x5 cm	
Total Packaging*		
	Melamine: 75,5 kg Laminate: 79,7 kg Veneer: 79,7 kg 0,068 m ³	

Table Top		
Product Code	L/W/H (cm)	Material
8256 03180080 01	180x80x2,5	Melamine
8256 03180080 02	180x80x2,5	Laminate
8256 03180080 03	180x80x2,5	Veneer
Gross Weight and Packaging		
	Melamine: 21,6 kg Laminate: 27 kg Veneer: 27 kg 183x83x5 cm	
Total Packaging*		
	Melamine: 77,3 kg Laminate: 82,7 kg Veneer: 82,7 kg 0,076 m ³	

* Total packaging include two leg, one table top, one telescopic travers and one lift setpack.

VARIATIONS

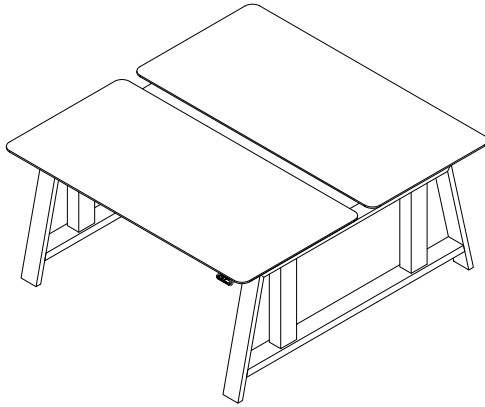

Double Desk



Leg / D Type



Product Code	L/W/H (cm)	Material
8256 100298 0000 06	148x19,8x65,3	Solid Wood
Gross Weight		
	29,6 kg	
Packaging		
	160x25x75 cm (0,3 m ³) 30,5 kg	

Table Top

Product Code	L/W/H (cm)	Material
8256 01140168 01	140x168x2,5	Melamine
8256 01140168 02	140x168x2,5	Laminate
8256 01140168 03	140x168x2,5	Veneer

Gross Weight and Packaging

	Melamine: 12,6 kg x 2 Laminate: 15,75 kg x 2 Veneer: 15,75 kg x 2 143x83x5 cm
---	--

Total Packaging*



	Melamine: 110,6 kg Laminate: 116,9 kg Veneer: 116,9 kg 1,866 m ³
---	--

Table Top

Product Code	L/W/H (cm)	Table Top
8256 01160168 01	160x168x2,5	Melamine
8256 01160168 02	160x168x2,5	Laminate
8256 01160168 03	160x168x2,5	Veneer

Gross Weight and Packaging

	Melamine: 19,8 kg x 2 Laminate: 24 kg x 2 Veneer: 24 kg x 2 163x83x5 cm
---	--

Total Packaging*



	Melamine: 125 kg Laminate: 133,4 kg Veneer: 133,4 kg 1,866 m ³
---	--

Table Top

Product Code	L/W/H (cm)	Material
8256 01180168 01	180x168x2,5	Melamine
8256 01180168 02	180x168x2,5	Laminate
8256 01180168 03	180x168x2,5	Veneer

Gross Weight and Packaging

	Melamine: 21,6 kg x 2 Laminate: 27 kg x 2 Veneer: 27 kg x 2 183x83x5 cm
---	--

Total Packaging*

	Melamine: 128,6 kg Laminate: 139,4 kg Veneer: 139,4 kg 1,9 m ³
---	--

* Total packaging include two leg, two table top, two telescopic travers and two lift setpack.

VARIATIONS





Leg / D1 Type		
Product Code	L/W/H (cm)	Material
8256 100302 0000 08	148x19,8x65,3	Metal
Gross Weight		
	37,5 kg	
Packaging		
	160x25x75 cm (0,3 m ³) 40 kg	



Table Top		
Product Code	L/W/H (cm)	Material
8256 02140168 01	140x168x2,5	Melamine
8256 02140168 02	140x168x2,5	Laminate
8256 02140168 03	140x168x2,5	Veneer
Gross Weight and Packaging		
	Melamine: 12,6 kg x 2 Laminate: 15,75 kg x 2 Veneer: 15,75 kg x 2 143x83x5 cm	
Total Packaging*		
	Melamine: 144 kg Laminate: 152,4 kg Veneer: 152,4 kg 1,866 m ³	





Table Top		
Product Code	L/W/H (cm)	Table Top
8256 02160168 01	160x168x2,5	Melamine
8256 02160168 02	160x168x2,5	Laminate
8256 02160168 03	160x168x2,5	Veneer
Gross Weight and Packaging		
	Melamine: 19,8 kg x 2 Laminate: 24 kg x 2 Veneer: 24 kg x 2 163x83x5 cm	
Total Packaging*		
	Melamine: 124,2 kg Laminate: 152,4 kg Veneer: 152,4 kg 1,884 m ³	

Table Top		
Product Code	L/W/H (cm)	Material
8256 02180168 01	180x168x2,5	Melamine
8256 02180168 02	180x168x2,5	Laminate
8256 02180168 03	180x168x2,5	Veneer
Gross Weight and Packaging		
	Melamine: 21,6 kg x 2 Laminate: 27 kg x 2 Veneer: 27 kg x 2 183x83x5 cm	
Total Packaging*		
	Melamine: 147,6 kg Laminate: 158,4 kg Veneer: 158,4 kg 1,9 m ³	

* Total packaging include two leg, two table top, two telescopic travers and two lift setpack.

VARIATIONS





Leg / D2 Type		
Product Code	L/W/H (cm)	Material
8256 100303 0000 19	148x19,8x65,3	Metal+Melamine
Gross Weight		
	38,5 kg	
Packaging		
	160x25x75 cm (0,3 m ³) 41 kg	



Table Top		
Product Code	L/W/H (cm)	Material
8256 03140168 01	140x168x2,5	Melamine
8256 03140168 02	140x168x2,5	Laminate
8256 03140168 03	140x168x2,5	Veneer
Gross Weight and Packaging		
	Melamine: 12,6 kg x 2 Laminate: 15,75 kg x 2 Veneer: 15,75 kg x 2 143x83x5 cm	
Total Packaging*		
	Melamine: 131,6 kg Laminate: 137,9 kg Veneer: 137,9 kg 1,866 m ³	





Table Top		
Product Code	L/W/H (cm)	Table Top
8256 03160168 01	160x168x2,5	Melamine
8256 03160168 02	160x168x2,5	Laminate
8256 03160168 03	160x168x2,5	Veneer
Gross Weight and Packaging		
	Melamine: 19,8 kg x 2 Laminate: 24 kg x 2 Veneer: 24 kg x 2 163x83x5 cm	
Total Packaging*		
	Melamine: 146 kg Laminate: 154,4 kg Veneer: 154,4 kg 1,884 m ³	

Table Top		
Product Code	L/W/H (cm)	Material
8256 03180168 01	180x168x2,5	Melamine
8256 03180168 02	180x168x2,5	Laminate
8256 03180168 03	180x168x2,5	Veneer
Gross Weight and Packaging		
	Melamine: 21,6 kg x 2 Laminate: 27 kg x 2 Veneer: 27 kg x 2 183x83x5 cm	
Total Packaging*		
	Melamine: 149,6 kg Laminate: 160,4 kg Veneer: 160,4 kg 1,9 m ³	

* Total packaging include two leg, two table top, two telescopic travers and two lift setpack.

ACCESSORIES

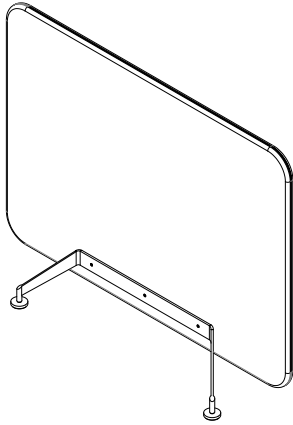

Seperate		
Product Code	L/W/H (cm)	Fabric
8256 03120115 01	120x45x115	Category 1
8256 03120115 02	120x45x115	Category 2
8256 03120115 03	120x45x115	Category 3

Gross Weight	
	Panel+Leg 16,5 kg

Packaging	
	Panel: 125x105x5 cm (0,066 m ³) / 9,3 kg Legs: 34x108x25 cm (0,092 m ³) / 8 kg

Seperate		
Product Code	L/W/H (cm)	Fabric
8256 03140115 01	140x45x115	Category 1
8256 03140115 01	140x45x115	Category 2
8256 03140115 01	140x45x115	Category 3

Gross Weight	
	Panel+Leg 17,6 kg

Packaging	
	Panel: 145x105x5 cm (0,076 m ³) / 10,4 kg Legs: 34x108x25 cm (0,092 m ³) / 8 kg

Seperate		
Product Code	L/W/H (cm)	Fabric
8256 03160050 01	160x45x115	Category 1
8256 03160050 02	160x45x115	Category 2
8256 03160050 03	160x45x115	Category 3

Gross Weight	
	19,1 kg

Packaging	
	Panel: 165x105x5 cm (0,087 m ³) / 11,9 kg Legs: 34x108x25 cm (0,092 m ³) / 8 kg

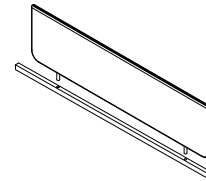

Fixed Seperate		
Product Code	L/W/H (cm)	Fabric
8256 04120050 01	120x3x50	Category 1
8256 04120050 02	120x3x50	Category 2
8256 04120050 03	120x3x50	Category 3

Gross Weight	
	5 kg

Packaging	
	125x5x55 cm (0,066 m ³) 6 kg

ACCESSORIES

Fixed Seperate		
Product Code	L/W/H (cm)	Fabric
8256 04140050 01	140x3x50	Category 1
8256 04140050 02	140x3x50	Category 2
8256 04140050 03	140x3x50	Category 3

Gross Weight	
	6 kg

Packaging	
	145x5x55 cm (0,076 m ³) 7 kg

Fixed Seperate		
Product Code	L/W/H (cm)	Fabric
8256 04160050 01	160x3x50	Category 1
8256 04160050 02	160x3x50	Category 2
8256 04160050 03	160x3x50	Category 3

Gross Weight	
	7 kg

Packaging	
	145x5x55 cm (0,087 m ³) 8 kg

Open-up two table-to-panel panel fittings. It is a single piece together with the panel.

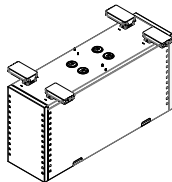

E-support	
Product Code	L/W/H (cm)
8256 1003060000 08	115x33x59

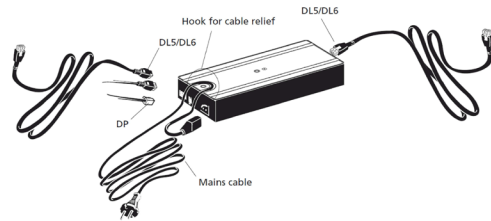

Lift Setpack	
Product Code	Color
8254 100316 0000 13	Black

Gross Weight	
	0,35 kg

Packaging	
	30x12x7 cm (0,002 m ³) 0,5 kg

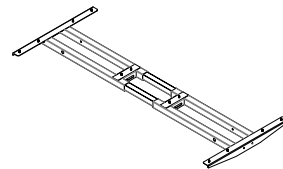

Telescopic Travers		
Product Code	L/W/H (cm)	Material
8256 100304 0000 08	126,6x60x4,4	Metal

Gross Weight	
	10,5 kg

Packaging	
	145x65x6 cm (0,57 m ³) 11,2 kg

ACCESSORIES



Vertabra	
Product Code	Color
8256 1002900000 10	Black

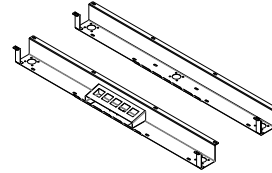

Socket Block	
Product Code	L (cm)
8256 1003190100 08	100 (for 120' table)
8256 1003290100 08	120 (for 140' table)
8256 1003210100 08	140 (for 160' table)

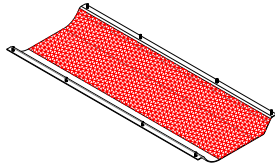

Cable Tray	
Product Code	Color
8254 1003150000 10	Black

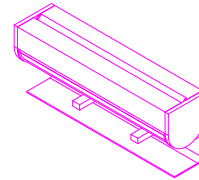

Portable Electricity	
Product Code	Color/Material
8241 1303301301	Black/Metal
8241 1303301302	White/Metal

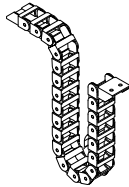

Cable Drag Chain	
Product Code	
8256 1003180000 13	

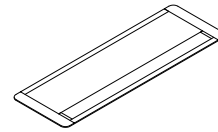

Aluminium Flap Cover	
Product Code	Material
6211 150101	Aluminium

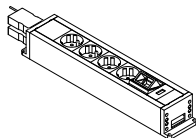

Office Electricity	
Product Code	
8254 1003170000 13	

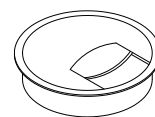

Cable Outlet	
Product Code	Color/Material
6923 10 12	Gray Material

ACCESSORIES

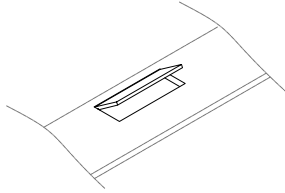

Wooden Flap Cover	
Product Code	Material
6211 230102M	Melamine
6211 230102L	Laminate
6211 230102K	Veneer

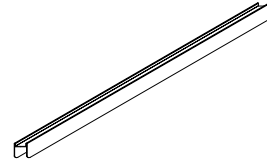

Hanger (for paper & note Holder) (Metal)	
Product Code	L (cm)
8219 3310004	100 (for 120' panel)
8219 3310005	120 (for 140' panel)
8219 3310006	140 (for 160' panel)



Control Panel	
Product Code	Color
8254 0000000002	Black

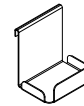

Paper Holder (Metal)	
Product Code	L/W/H (cm)
8219 3410004	12x9x15

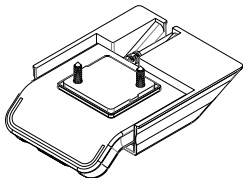

Smart Control Panel	
Product Code	Color
8254 0000000001	Black

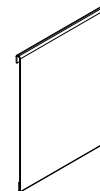

Note Holder (Metal)	
Product Code	L/H (cm)
8219 3410003	22x30

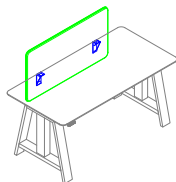

Light Panel	
Product Code	L/W/H (cm)
8253 1003240000 10	120x3x70
8253 1003270000 10	140x3x70
8253 1003280000 10	160x3x70

DESKTOP FINISHES

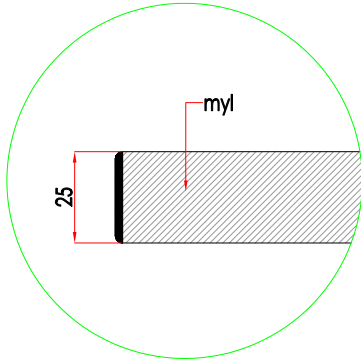

Melamine

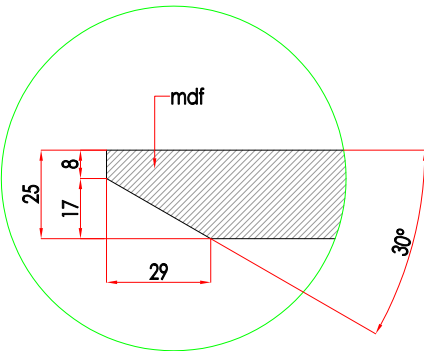

Laminate

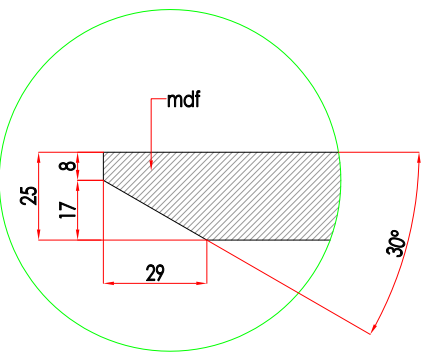

Veneer

INFORMATION

Combinations

You can combine with chairs and storage units.

Please, see Product Data Sheets for Chairs and Storage Units.

Fabrics for Seperations

You can use all fabrics from Category 1, Category 2, Category 3.

Please, see Product Data Sheets for Fabrics.

Category 1: Lucia.

Category 2: Urban Plus, Gravity, Chateau Plus.

Category 3: Synergy, Nexus.

Legs

Legs are from solid wood, metal and melamine.

Please, see Product Data Sheets for Material.

Table Top

Table tops are melamine, laminate and veneer.

Please, see Product Data Sheets for Material.

Weight & Packaging

Weight and packaging dimensions may change according order composition of workstations. Please, contact with Export department.