

PRODUCT DATA SHEET

LEA

Table System

DESIGN

Ozan Sinan Tiğlioğlu



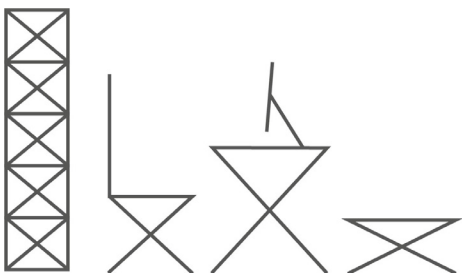

“LEA” is the name of a princess in the famous movie Star Wars. She is a symbol of an elegant, strong and resisting character. Design concept of our new desking system LEA is mainly based on strong and elegant wooden legs supporting the table top providing a static stance.





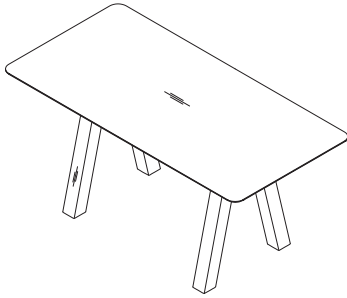

tunaofis



VARIATIONS



Single Desk		
Product Code	L/W/H (cm)	Material
8239 0116004P	160x80x75	Veneer+Veneer
8239 0116005P	160x80x75	Laminate+Veneer
Gross Weight		
	Legs: 6,3 kg x 2 One Table Top and Two Travers: 20,6 kg	
Packaging		
	Legs: 33,8x80,7x22 cm / 7,3 kg / 0,06 m ³ x 2 One Table Top and Two Travers: 162x92x7 cm / 21,6 kg / 0,104 m ³	

Product Code	L/W/H (cm)	Material
8239 0320004P	200x80x75	Veneer+Veneer
8239 0320005P	200x80x75	Laminate+Veneer
Gross Weight		
	Legs: 6,3 kg x 2 One Table Top and Two Travers: 25,72 kg	
Packaging		
	Legs: 33,8x80,7x22 cm / 7,3 kg / 0,06 m ³ x 2 One Table Top and Two Travers: 202x92x7 cm / 26,96 kg / 0,130 m ³	

Product Code	L/W/H (cm)	Material
8239 0420004P	200x90x75	Veneer+Veneer
8239 0420005P	200x90x75	Laminate+Veneer
Gross Weight		
	Legs: 6,3 kg x 2 One Table Top and Two Travers: 28,22 kg	
Packaging		
	Legs: 33,8x80,7x22 cm / 7,3 kg / 0,06 m ³ x 2 One Table Top and Two Travers: 202x102x7 cm / 29,58 kg / 0,140 m ³	

Product Code	L/W/H (cm)	Material
8239 0218004P	180x80x75	Veneer+Veneer
8239 0218005P	180x80x75	Laminate+Veneer
Gross Weight		
	Legs: 6,3 kg x 2 One Table Top and Two Travers: 23,14 kg	
Packaging		
	Legs: 33,8x80,7x22 cm / 7,3 kg / 0,06 m ³ x 2 One Table Top and Two Travers: 182x92x7 cm / 24,26 kg / 0,117 m ³	

VARIATIONS

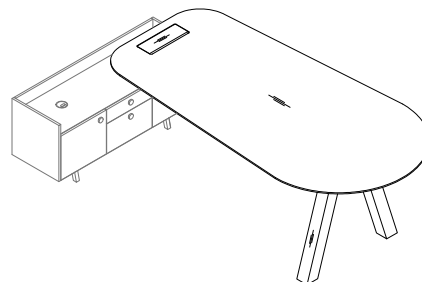
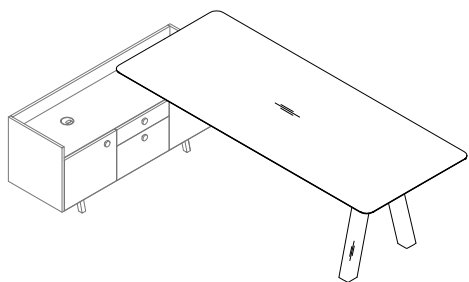

Single Desk with Console		
Product Code	L/W/H (cm)	Material
8239 0516004P	160x80x75	Veneer+Veneer
8239 0516005P	160x80x75	Laminate+Veneer

Single Desk with Console		
Product Code	L/W/H (cm)	Material
8239 0920004P	200x100x75	Veneer+Veneer
8239 0920005P	200x100x75	Laminate+Veneer

Product Code	L/W/H (cm)	Material
8239 0618004P	180x80x75	Veneer+Veneer
8239 0618005P	180x80x75	Laminate+Veneer

Product Code	L/W/H (cm)	Material
8239 0720004P	200x80x75	Veneer+Veneer
8239 0720005P	200x80x75	Laminate+Veneer

Product Code	L/W/H (cm)	Material
8239 0820004P	200x90x75	Veneer+Veneer
8239 0820005P	200x90x75	Laminate+Veneer

VARIATIONS

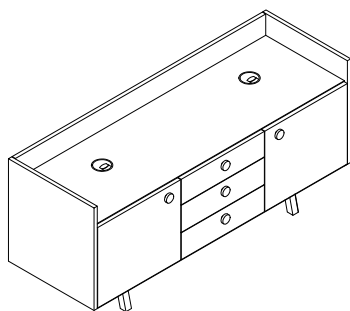

Console with 3 Drawers		
Product Code	L/W/H (cm)	Back/Top/Door
8239 1014501	145x50x63	Mel. / Mel. / Mel.
8239 1014502	145x50x63	Lam. / Mel. / Mel.
8239 1014503	145x50x63	Ven. / Mel. / Mel.
8239 1014504	145x50x63	Ven. / Ven. / Ven.

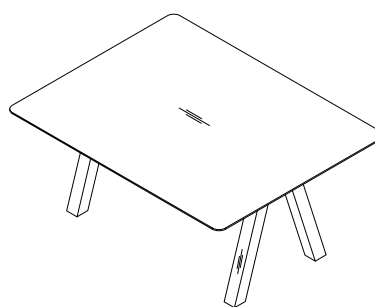

Group Desk for Two		
Product Code	L/W/H (cm)	Top/Leg
8239 1412004P	120x130x75	Veneer/Veneer
8239 1412005P	120x130x75	Laminate/Veneer
8239 1412014P	120x160x75	Veneer/Veneer
8239 1412015P	120x160x75	Laminate/Veneer

Console with 2 Drawers		
Product Code	L/W/H (cm)	Back/Top/Door
8239 1114501	145x50x63	Mel. / Mel. / Mel.
8239 1114502	145x50x63	Lam. / Mel. / Mel.
8239 1114503	145x50x63	Ven. / Mel. / Mel.
8239 1114504	145x50x63	Ven. / Ven. / Ven.

Product Code	L/W/H (cm)	Top/Leg
8239 1514004P	140x130x75	Veneer/Veneer
8239 1514005P	140x130x75	Laminate/Veneer
8239 1514014P	140x160x75	Veneer/Veneer
8239 1514015P	140x160x75	Laminate/Veneer

Product Code	L/W/H (cm)	Top/Leg
8239 1616004P	160x130x75	Veneer/Veneer
8239 1616005P	160x130x75	Laminate/Veneer
8239 1616014P	160x160x75	Veneer/Veneer
8239 1616015P	160x160x75	Laminate/Veneer

VARIATIONS

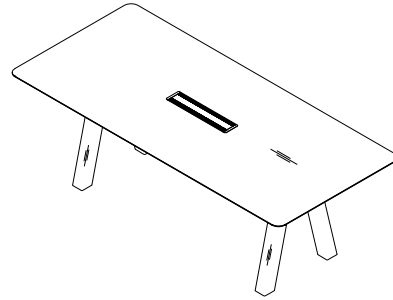
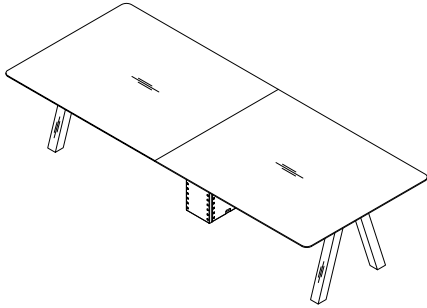

Group Desk for Four		
Product Code	L/W/H (cm)	Top/Leg
8239 1724004P	240x130x75	Veneer/Veneer
8239 1724005P	240x130x75	Laminate/Veneer
8239 1724014P	240x160x75	Veneer/Veneer
8239 1724015P	240x160x75	Laminate/Veneer

Meeting Table		
Product Code	L/W/H (cm)	Top/Leg
8239 2420004P	200x100x75	Veneer/Veneer
8239 2420005P	200x100x75	Laminate/Veneer

Product Code	L/W/H (cm)	Top/Leg
8239 1828004P	280x130x75	Veneer/Veneer
8239 1828005P	280x130x75	Laminate/Veneer
8239 1828014P	280x160x75	Veneer/Veneer
8239 1828015P	280x160x75	Laminate/Veneer

Product Code	L/W/H (cm)	Top/Leg
8239 2526004P	260x100x75	Veneer/Veneer
8239 2526005P	260x100x75	Laminate/Veneer

Product Code	L/W/H (cm)	Top/Leg
8239 1932004P	320x130x75	Veneer/Veneer
8239 1932005P	320x130x75	Laminate/Veneer
8239 1932014P	320x160x75	Veneer/Veneer
8239 1932015P	320x160x75	Laminate/Veneer

Product Code	L/W/H (cm)	Top/Leg
8239 2620004P	200x120x75	Veneer/Veneer
8239 2620005P	200x120x75	Laminate/Veneer

Product Code	L/W/H (cm)	Top/Leg
8239 2726004P	260x120x75	Veneer/Veneer
8239 2726005P	260x120x75	Laminate/Veneer

Product Code	L/W/H (cm)	Top/Leg
8239 3020004P	200x100x105	Veneer/Veneer
8239 3020005P	200x100x105	Laminate/Veneer

Product Code	L/W/H (cm)	Top/Leg
8239 3126004P	260x100x105	Veneer/Veneer
8239 3126005P	260x100x105	Laminate/Veneer

VARIATIONS

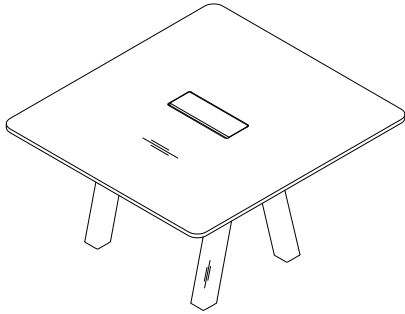

Meeting Table		
Product Code	L/W/H (cm)	Top/Leg
8239 2812004P	120x120x75	Veneer/Veneer
8239 2812005P	120x120x75	Laminate/Veneer

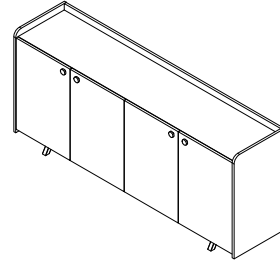

Cabinet with 4 Door		
Product Code	L/W/H (cm)	Back/Top/Door
8239 3320001	200x46x87	Mel. / Mel. / Mel.
8239 3320002	200x46x87	Lam. / Mel. / Mel.
8239 3320003	200x46x87	Ven. / Mel. / Mel.
8239 3320004	200x46x87	Ven. / Ven. / Ven.

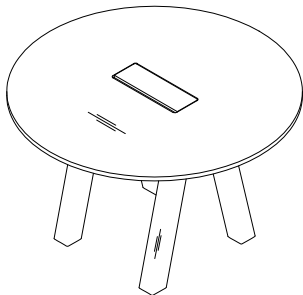

Meeting Table		
Product Code	Q/H (cm)	Top/Leg
8239 2912004P	120x75	Veneer/Veneer
8239 2912005P	120x75	Laminate/Veneer

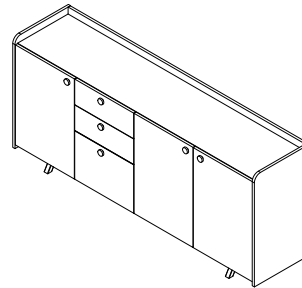

Cabinet with Drawers		
Product Code	L/W/H (cm)	Back/Top/Door
8239 3420001	200x46x87	Mel. / Mel. / Mel.
8239 3420002	200x46x87	Lam. / Mel. / Mel.
8239 3420003	200x46x87	Ven. / Mel. / Mel.
8239 3420004	200x46x87	Ven. / Ven. / Ven.

VARIATIONS

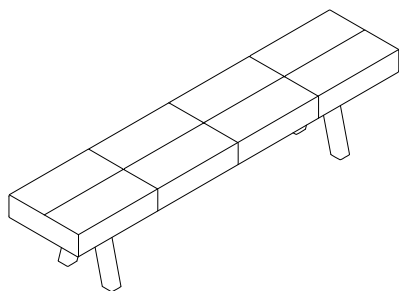

Bench		
Product Code	L/W/H (cm)	Fabric
8239 3514001	140x45x45	Category 1
8239 3514002	140x45x45	Category 2
8239 3514003	140x45x45	Category 3
8239 3516001	160x45x45	Category 1
8239 3516002	160x45x45	Category 2
8239 3516003	160x45x45	Category 3
8239 3518001	180x45x45	Category 1
8239 3518002	180x45x45	Category 2
8239 3518003	180x45x45	Category 3
8239 3520001	200x45x45	Category 1
8239 3520002	200x45x45	Category 2
8239 3520003	200x45x45	Category 3
8239 3522001	220x45x45	Category 1
8239 3522002	220x45x45	Category 2
8239 3522003	220x45x45	Category 3
8239 3528001	280x45x45	Category 1
8239 3528002	280x45x45	Category 2
8239 3528003	280x45x45	Category 3
8239 3532001	320x45x45	Category 1
8239 3532002	320x45x45	Category 2
8239 3532003	320x45x45	Category 3

ACCESSORIES

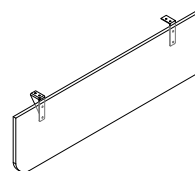

Wooden/Acrylic Front Panel		
Product Code	L/W/H (cm)	Material
8239 1210001	100x1,8x36 (for 160' table)	Melamine
8239 1210002	100x1,8x36 (for 160' table)	Laminate
8239 1210003	100x1,8x36 (for 160' table)	Veneer
8239 1212001	120x1,8x36 (for 180' table)	Melamine
8239 1212002	120x1,8x36 (for 180' table)	Laminate
8239 1212003	120x1,8x36 (for 180' table)	Veneer
8239 1214001	140x1,8x36 (for 200' table)	Melamine
8239 1214002	140x1,8x36 (for 200' table)	Laminate
8239 1214003	140x1,8x36 (for 200' table)	Veneer
8239 1310001	100x0,8x36 (for 160' table)	Acrylic
8239 1312001	120x0,8x36 (for 180' table)	Acrylic
8239 1314001	140x0,8x36 (for 200' table)	Acrylic

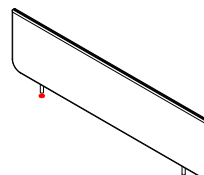

Panel for Table Top		
Product Code	L/W/H (cm)	Material
8239 2310001	100x3x35 (for 100' table)	Fabric
8239 2312001	120x3x35 (for 120' table)	Fabric
8239 2314001	140x3x35 (for 140' table)	Fabric

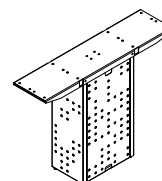

E-support		
Product Code	L/W/H (cm)	Material
8239 0000050000 08	79x25x72,5	Painted
8239 0000060000 08	99x25x72,5	Painted

ACCESSORIES

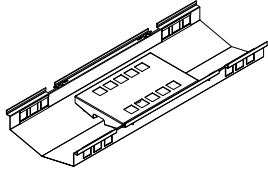

Cable Tray		
Product Code	L/W/H (cm)	Material
8239 3214001	140x37,5x11,7	Metal
8239 3212001	120x37,5x11,7	Metal
8239 3210001	100x37,5x11,7	Metal
8239 3208001	80x37,5x11,7	Metal

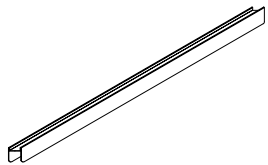

Hanger (for paper & note Holder) (Metal)	
Product Code	L (cm)
8219 3310003	90 (for 100" panel)
8219 3310004	100 (for 120" panel)
8219 3310005	120 (for 140" panel)

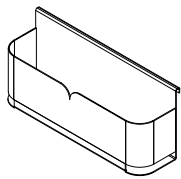

Note Holder (Metal)	
Product Code	L/W/H (cm)
8239 3603001	30x8x13

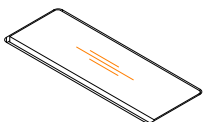

Wooden Flap	
Product Code	Material
6211 230102L	Laminate
6211 230102K	Veneer

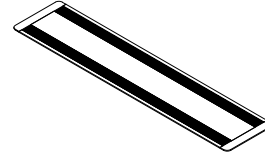

Aluminium Flap
Product Code
6211 150101

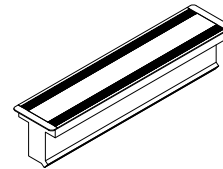

Aluminium Flap (Two Way Cover)
Product Code
92800 EUKONN TWOWAY

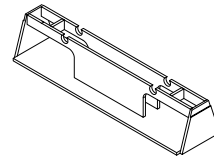

Bag Holder		
Product Code	L/W/H (cm)	Material
8239 0001240100 03	92x40x29,8	Veneer
8239 0001240100 02	92x40x29,8	Laminate
8239 0001250100 03	152x40x29,8	Veneer
8239 0001250100 02	152x40x29,8	Laminate

INFORMATION

Combinations

You can combine with chairs and drawers.

Please, see Product Data Sheets for Chairs and Drawers.

Fabrics

You can use fabrics from Category 1, Category 2, Category 3.

Please, see Product Data Sheets for Fabrics.

Category 1: Lucia.

Category 2: Urban Plus, Gravity, Chateau Plus.

Category 3: Synergy, Nexus.

Materials

Materials are melamine, laminate, solid wood and veneer.

Please, see Product Data Sheets for Material.

Weight & Packaging

Weight and packaging dimensions may change according order composition of workstations. Please, contact with Export department.

